

# CGHV1F025S

25 W, DC - 15 GHz, 40V, GaN HEMT

Cree's CGHV1F025S is an unmatched, gallium nitride (GaN) high electron mobility transistor (HEMT) designed specifically for high efficiency, high gain and wide bandwidth capabilities. The device can be deployed for L, S, C, X and Ku-Band amplifier applications. The datasheet specifications are based on a X-Band (8.9 - 9.6 GHz) amplifier. The CGHV1F025S operates on a 40 volt rail circuit while housed in a 3mm x 4mm, surface mount, dual-flat-no-lead (DFN) package. Under reduced power, the transistor can operate below 40V to as low as 20V  $V_{DD}$ , maintaining high gain and efficiency.

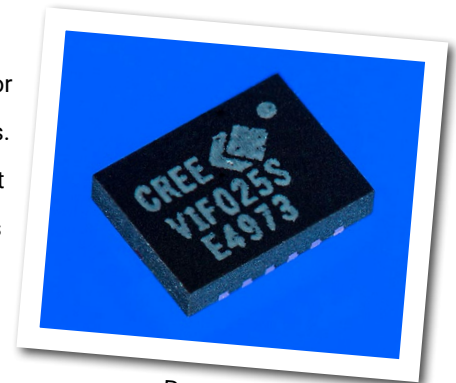

Package Type: 3x4 DFN  
PN: CGHV1F025S

## Typical Performance 8.9 - 9.6 GHz ( $T_c = 25^\circ\text{C}$ ), 40 V

Parameter	8.9 GHz	9.2 GHz	9.4 GHz	9.6 GHz	Units
Output Power @ $P_{IN} = 37$ dBm	24	29	27	25	W
Drain Efficiency @ $P_{IN} = 37$ dBm	43.5	48.5	48	46	%
Gain @ $P_{IN} = 0$ dBm	10.7	11.6	11.3	11.1	dB

Note:  
Measured in the CGHV1F025S-AMP1 application circuit. Pulsed 100  $\mu\text{s}$  10% duty.

## Features

- Up to 15 GHz Operation
- 25 W Typical Output Power
- 11 dB Gain at 9.4 GHz
- Application circuit for 8.9 - 9.6 GHz

## Absolute Maximum Ratings (not simultaneous) at 25°C Case Temperature

Parameter	Symbol	Rating	Units	Notes
Drain-Source Voltage	$V_{DSS}$	100	Volts	25°C
Gate-to-Source Voltage	$V_{GS}$	-10, +2	Volts	25°C
Storage Temperature	$T_{STG}$	-65, +150	°C	
Operating Junction Temperature	$T_J$	225	°C	
Maximum Forward Gate Current	$I_{GMAX}$	4.8	mA	25°C
Maximum Drain Current <sup>1</sup>	$I_{DMAX}$	2	A	25°C
Soldering Temperature <sup>2</sup>	$T_S$	245	°C	
Case Operating Temperature <sup>3,4</sup>	$T_C$	-40, +150	°C	
Thermal Resistance, Junction to Case <sup>5</sup>	$R_{\theta JC}$	3.4	°C/W	85°C

Note:

<sup>1</sup> Current limit for long term, reliable operation

<sup>2</sup> Refer to the Application Note on soldering at [www.cree.com/rf/document-library](http://www.cree.com/rf/document-library)

<sup>3</sup> Simulated at  $P_{DISS} = 2.4$  W

<sup>4</sup>  $T_C$  = Case temperature for the device. It refers to the temperature at the ground tab underneath the package. The PCB will add additional thermal resistance.

<sup>5</sup> Pulsed (100  $\mu$ s, 10% Duty). Rth for Cree's reference design using a 10 mil Rogers 5880 PCB with 31 ( $\varnothing$ 13 mil) Vias would be 3.6 °C/W.

For CW operation, the Rth numbers increase to 5°C/W for just the device, and 7.3 °C/W including the board.

## Electrical Characteristics ( $T_C = 25^\circ\text{C}$ ) - 40 V Typical

Characteristics	Symbol	Min.	Typ.	Max.	Units	Conditions
<b>DC Characteristics<sup>1</sup></b>						
Gate Threshold Voltage	$V_{GS(th)}$	-3.8	-3.0	-2.3	$V_{DC}$	$V_{DS} = 10$ V, $I_D = 4.8$ mA
Gate Quiescent Voltage	$V_{GS(Q)}$	-	-2.7	-	$V_{DC}$	$V_{DS} = 40$ V, $I_D = 240$ mA
Saturated Drain Current <sup>2</sup>	$I_{DS}$	3.8	4.3	-	A	$V_{DS} = 6.0$ V, $V_{GS} = 2.0$ V
Drain-Source Breakdown Voltage	$V_{(BR)DSS}$	100	-	-	$V_{DC}$	$V_{GS} = -8$ V, $I_D = 4.8$ mA
<b>RF Characteristics<sup>3</sup> (<math>T_C = 25^\circ\text{C}</math>, <math>F_0 = 6.0</math> GHz unless otherwise noted)</b>						
Gain	G	-	16	-	dB	$V_{DD} = 40$ V, $I_{DQ} = 150$ mA, $P_{IN} = 0$ dBm
Output Power <sup>4</sup>	$P_{OUT}$	-	29	-	W	$V_{DD} = 40$ V, $I_{DQ} = 150$ mA, $P_{IN} = 34$ dBm
Drain Efficiency <sup>4</sup>	$\eta$	-	55	-	%	$V_{DD} = 40$ V, $I_{DQ} = 150$ mA, $P_{IN} = 34$ dBm
Output Mismatch Stress <sup>4</sup>	VSWR	-	10 : 1	-	Y	No damage at all phase angles, $V_{DD} = 40$ V, $I_{DQ} = 150$ mA, $P_{OUT} = 29$ W
<b>Dynamic Characteristics</b>						
Input Capacitance <sup>5</sup>	$C_{GS}$	-	5.9	-	pF	$V_{DS} = 40$ V, $V_{gs} = -8$ V, $f = 1$ MHz
Output Capacitance <sup>5</sup>	$C_{DS}$	-	2	-	pF	$V_{DS} = 40$ V, $V_{gs} = -8$ V, $f = 1$ MHz
Feedback Capacitance	$C_{GD}$	-	0.21	-	pF	$V_{DS} = 40$ V, $V_{gs} = -8$ V, $f = 1$ MHz

Notes:

<sup>1</sup> Measured on wafer prior to packaging

<sup>2</sup> Scaled from PCM data

<sup>3</sup> Measured in CGHV1F025S-AMP

<sup>4</sup> Pulsed 100  $\mu$ s, 10% duty cycle

<sup>5</sup> Includes package

## Electrical Characteristics When Tested in CGHV1F025S-AMP1

Characteristics	Symbol	Min.	Typ.	Max.	Units	Conditions
RF Characteristics <sup>1</sup> ( $T_c = 25^\circ\text{C}$ , $F_o = 8.9 - 9.6\text{ GHz}$ unless otherwise noted)						
Gain	G	-	11.6	-	dB	$V_{DD} = 40\text{ V}$ , $I_{DQ} = 150\text{ mA}$ , $P_{IN} = 0\text{ dBm}$
Output Power <sup>2</sup>	$P_{OUT}$	-	29	-	W	$V_{DD} = 40\text{ V}$ , $I_{DQ} = 150\text{ mA}$ , $P_{IN} = 37\text{ dBm}$
Drain Efficiency <sup>2</sup>	$\eta$	-	48.5	-	%	$V_{DD} = 40\text{ V}$ , $I_{DQ} = 150\text{ mA}$ , $P_{IN} = 37\text{ dBm}$
Output Mismatch Stress <sup>2</sup>	VSWR	-	10 : 1	-	Y	$V_{DS} = 40\text{ V}$ , $V_{gs} = -8\text{ V}$ , $P_{OUT} = 25\text{ W}$

Notes:

<sup>1</sup> Measured in CGHV1F025S-AMP1 Application Circuit

<sup>2</sup> Pulsed 100  $\mu\text{s}$ , 10% duty cycle

## Typical Performance - CGHV1F025S-AMP1

Figure 1. - Typical Small Signal Response of CGHV1F025S-AMP1 Application Circuit  
 $V_{DD} = 40\text{ V}$ ,  $I_{DQ} = 150\text{ mA}$

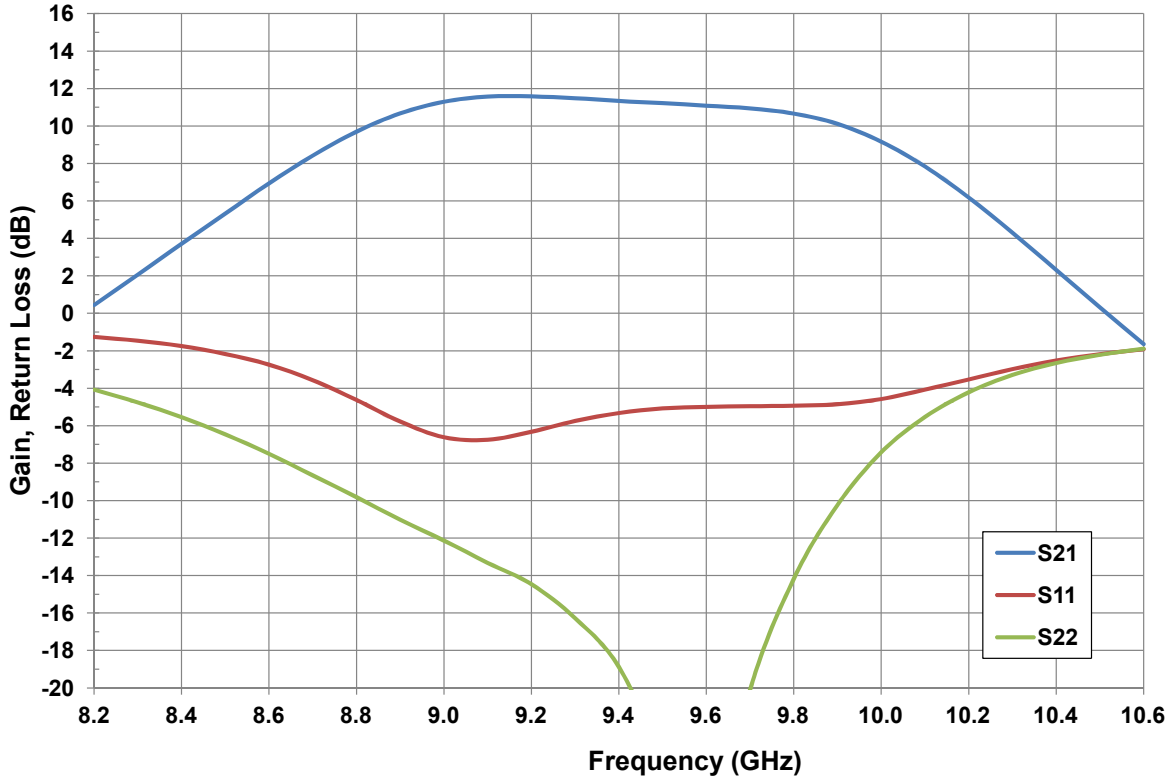

## Typical Performance in Application Circuit CGHV1F025S-AMP1

**Figure 2. - Typical Large Signal Response**  
 $V_{DD} = 40\text{ V}$ ,  $I_{DQ} = 150\text{ mA}$ ,  $P_{IN} = 37\text{ dBm}$   
 $T_{case} = 25^\circ\text{C}$ , Pulse Width =  $100\ \mu\text{s}$ , Duty Cycle = 10 %

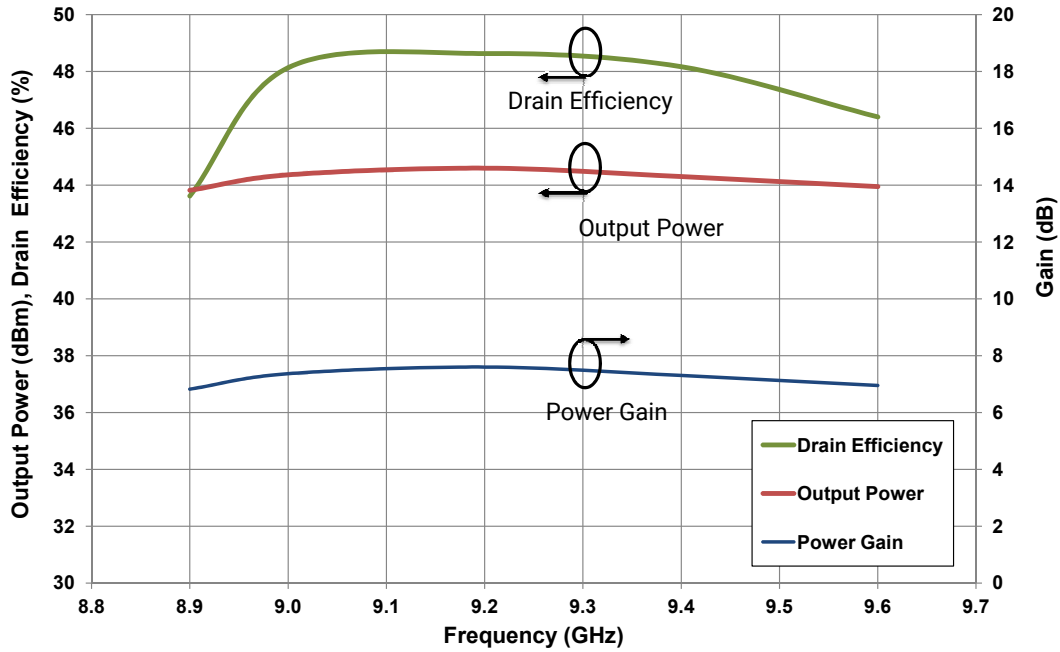

**Figure 3. -  $G_{MAX}$  and K-Factor vs Frequency**  
 $V_{DD} = 40\text{ V}$ ,  $I_{DQ} = 150\text{ mA}$ ,  $T_{case} = 25^\circ\text{C}$

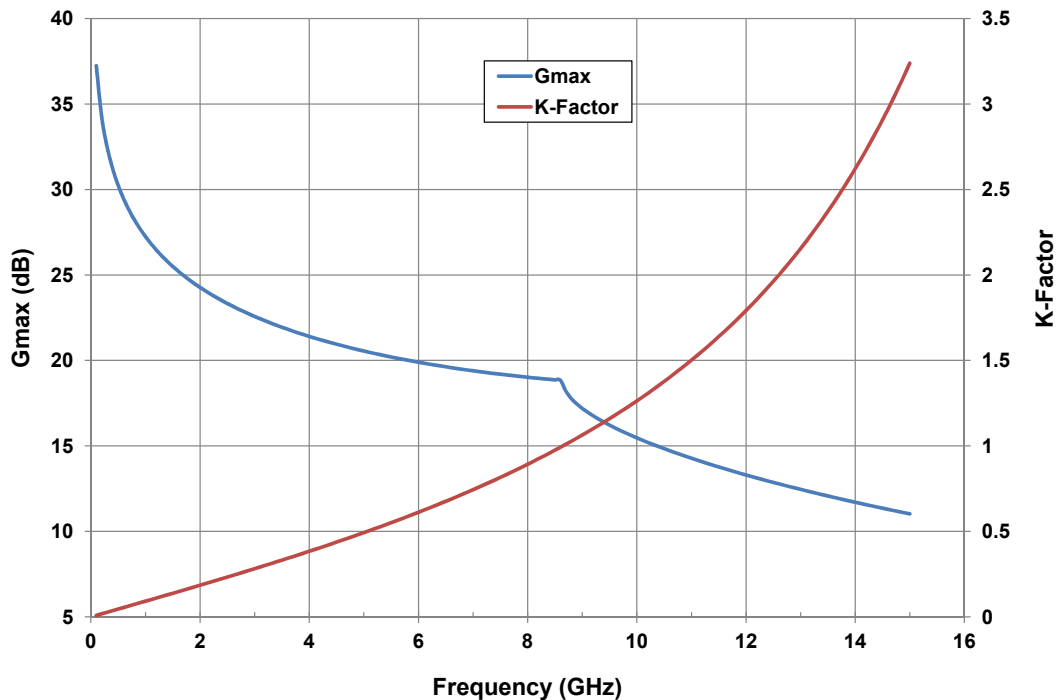

## CGHV1F025S-AMP1 Application Circuit Bill of Materials

Designator	Description	Qty
R1	RES, 100, OHM, +1/-1%, 1/16 W, 0603	1
R2	RES, 10, OHM, +1/-1%, 1/16 W, 0603	1
C1, C2	CAP, 1pF, ±0.1 pF, 0603, ATC	2
C3, C4	CAP, 1.8pF, ±0.1 pF, 0603, ATC	2
C9, C10	CAP, 0.6pF, ±0.1 pF, 0603, ATC	2
C5, C11	CAP, 10 pF, ±5%, 0603, ATC	1
C6, C12	CAP, 470 pF, 5%, 100 V, 0603, X	2
C7, C13	CAP, 33000 pF, 0805, 100V, X7R	2
C14	CAP, 1.0 UF, 100V, 10%, X7R, 1210	1
C8	CAP, 10 UF, 16V TANTALUM	1
C15	CAP, 33UF, 20%, G CASE	1
J1, J2	CONN, SMA, PANEL MOUNT JACK, FLANGE	2
J3	HEADER RT>PLZ .1CEN LK 5POS	1
Q1	QFN TRANSISTOR CGHV1F025S	1
W1	CABLE, 18 AWG, 4.2	1
	Rogers 5880 PCB 10 mils	1

## CGHV1F025S-AMP1 Application Circuit

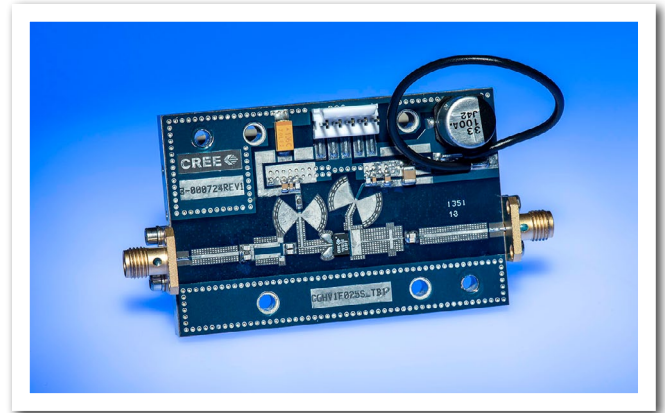

## Source and Load Impedances

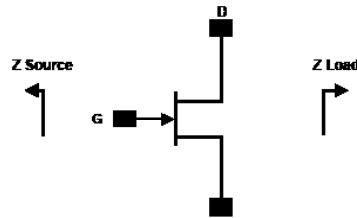

Frequency (MHz)	Z Source	Z Load
700	0.88 - j9.7	3.48 - j2.14
800	1.07 - j12.1	3.07 - j4.13
900	1.12 - j14.74	2.87 - j6.82
1000	1.15 - j17.64	2.49 - j9.63
1100	1.26 - j20.96	1.75 - j12.30

Note:  $V_{DD} = 40\text{ V}$ ,  $I_{DQ} = 150\text{ mA}$  in the 3x4 DFN package.

## Electrostatic Discharge (ESD) Classifications

Parameter	Symbol	Class	Test Methodology
Human Body Model	HBM	1A (> 250 V)	JEDEC JESD22 A114-D
Charge Device Model	CDM	2 (125 V to 250 V)	JEDEC JESD22 C101-C

## CGHV1F025S-AMP1 Application Circuit Schematic

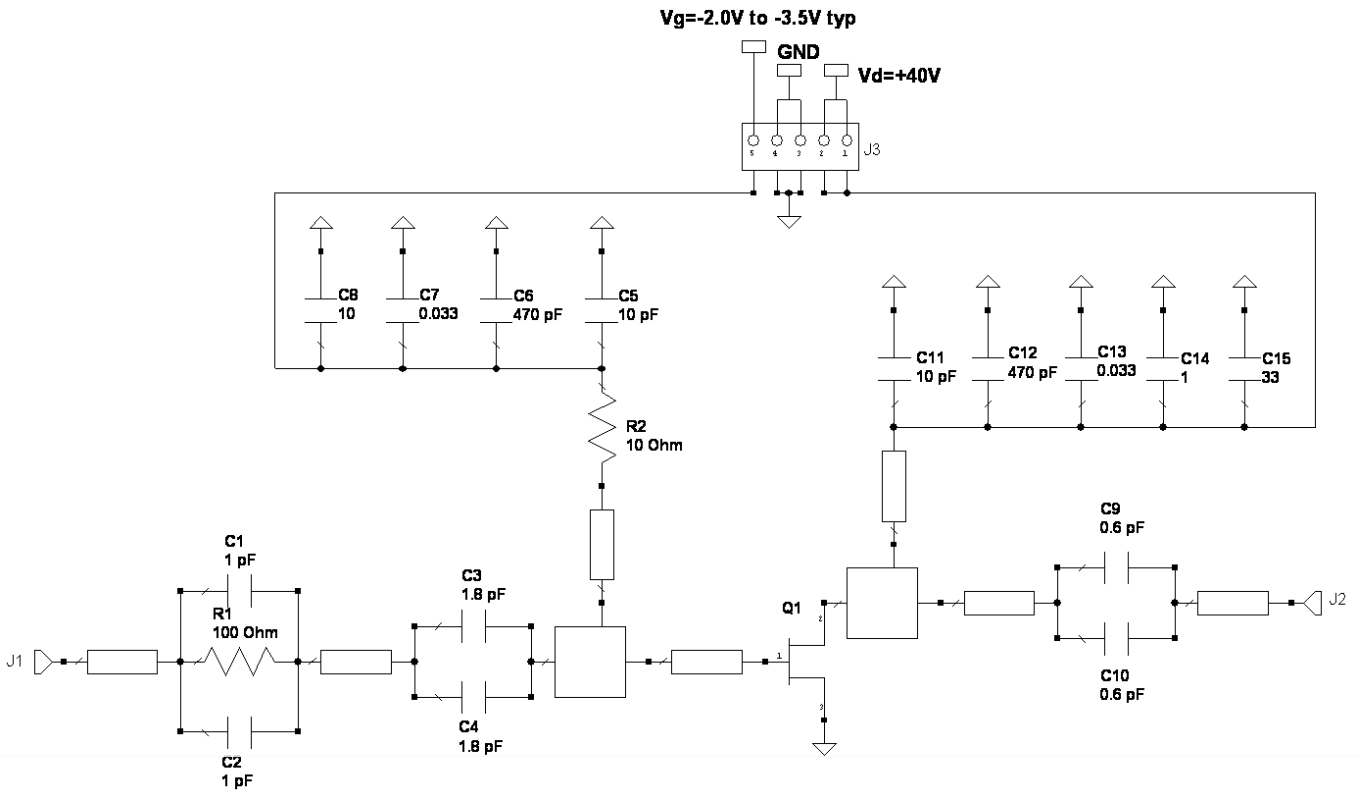

## CGHV1F025S-AMP1 Application Circuit Outline

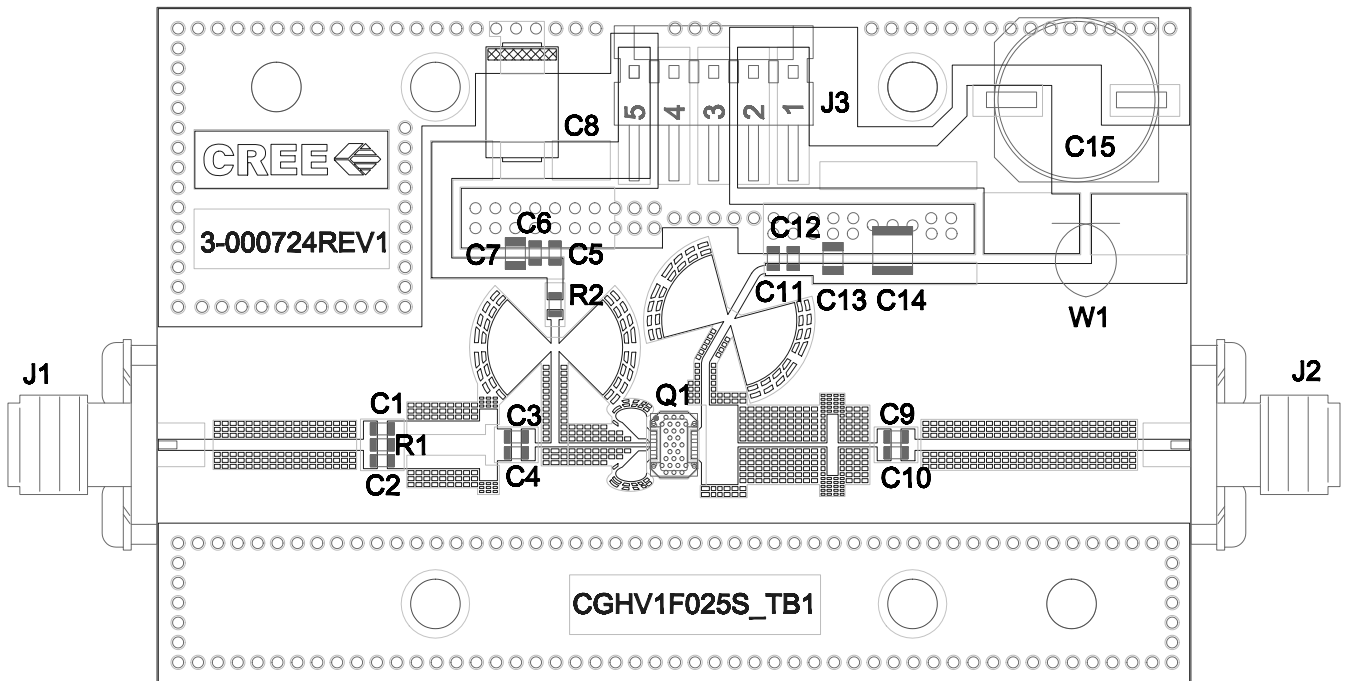

## Product Dimensions CGHV1F025S (Package 3 x 4 DFN)

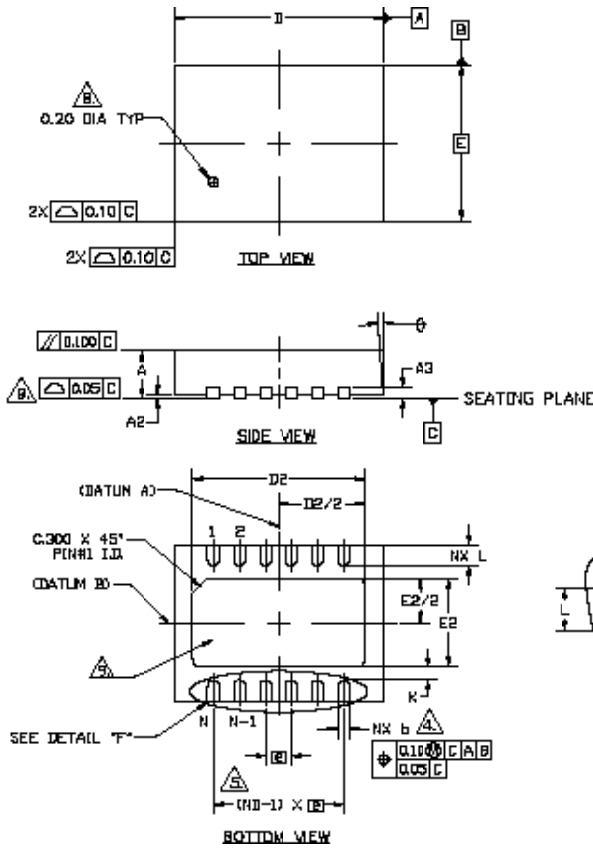

### NOTES :

1. DIMENSIONING AND TOLERANCING CONFORM TO ASME Y14.5M – 1994.
2. ALL DIMENSIONS ARE IN MILLIMETERS,  $\theta$  IS IN DEGREES.
3. N IS THE TOTAL NUMBER OF TERMINALS.
4. DIMENSION b APPLIES TO METALIZED TERMINAL AND IS MEASURED BETWEEN .15 AND .30mm FROM TERMINAL TIP. IF THE TERMINAL HAS THE OPTIONAL RADIUS ON THE OTHER END OF THE TERMINAL, THE DIMENSION b SHOULD NOT BE MEASURED IN THAT RADIUS AREA.
5. ND REFERS TO THE NUMBER OF TERMINALS ON D SIDE
6. MAXIMUM PACKAGE WARPAGE IS .05 mm.
7. MAXIMUM ALLOWABLE BURRS IS .076 mm IN ALL DIRECTIONS.
8. PIN #1 ID ON TOP WILL BE LASER MARKED.
9. UNILATERAL COPLANARITY ZONE APPLIES TO THE EXPOSED HEAT SINK SLUG AS WELL AS THE TERMINALS.

COMMON DIMENSIONS				N <sub>RF</sub>
	MIN	NOM.	MAX.	
A	0.80	0.85	0.90	
A1	0.00	0.02	0.05	
A3	0.20J REF.			
$\theta$	B	—	1.2	2
D	4.00 BSC			
E	3.00 BSC			
F	0.50 BSC			
N	n			3
ND	12			4
L	0.35	0.40	0.45	
b	0.17	0.22	0.27	4
D2	3.20	3.30	3.40	
E2	1.60	1.7	1.80	
K	0.20	—	—	

Pin	Input/Output
1	GND
2	RF IN
3	RF IN
4	RF IN
5	RF IN
6	GND
7	GND
8	RF OUT
9	RF OUT
10	RF OUT
11	RF OUT
12	GND

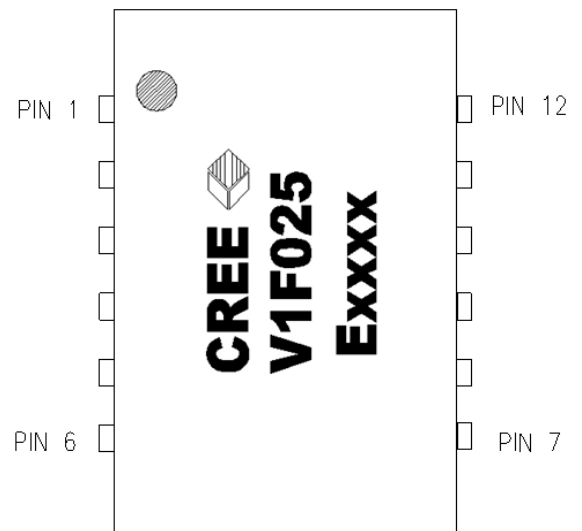

Note: Leadframe finish for 3x4 DFN package is Nickel/Palladium/Gold. Gold is the outer layer.

### CGHV1F025S

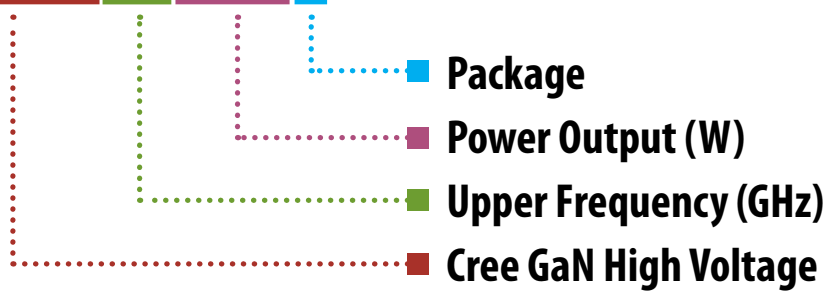

Parameter	Value	Units
Upper Frequency <sup>1</sup>	15.0	GHz
Power Output	25	W
Package	Surface Mount	-

**Table 1.**

**Note<sup>1</sup>:** Alpha characters used in frequency code indicate a value greater than 9.9 GHz. See Table 2 for value.

Character Code	Code Value
A	0
B	1
C	2
D	3
E	4
F	5
G	6
H	7
J	8
K	9
Examples:	1A = 10.0 GHz 2H = 27.0 GHz

**Table 2.**

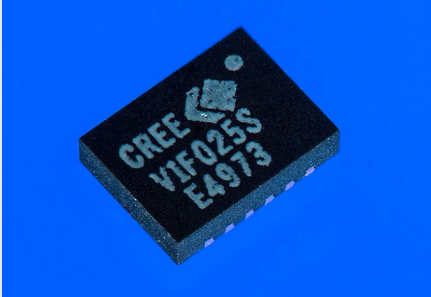
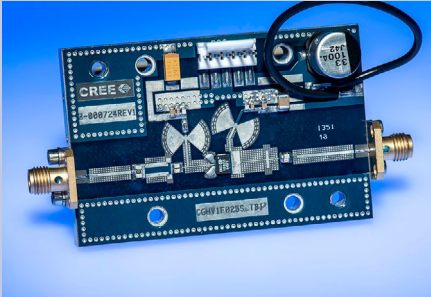

## Product Ordering Information

Order Number	Description	Unit of Measure	Image
CGHV1F025S	GaN HEMT	Each	
CGHV1F025-AMP1	Test board with GaN HEMT installed	Each	
CGHV1F025S-TR	Delivered in Tape and Reel	250 parts / reel	



## Disclaimer

Specifications are subject to change without notice. Cree, Inc. believes the information contained within this data sheet to be accurate and reliable. However, no responsibility is assumed by Cree for any infringement of patents or other rights of third parties which may result from its use. No license is granted by implication or otherwise under any patent or patent rights of Cree. Cree makes no warranty, representation or guarantee regarding the suitability of its products for any particular purpose. "Typical" parameters are the average values expected by Cree in large quantities and are provided for information purposes only. These values can and do vary in different applications and actual performance can vary over time. All operating parameters should be validated by customer's technical experts for each application. Cree products are not designed, intended or authorized for use as components in applications intended for surgical implant into the body or to support or sustain life, in applications in which the failure of the Cree product could result in personal injury or death or in applications for planning, construction, maintenance or direct operation of a nuclear facility.

For more information, please contact:

Cree, Inc.  
4600 Silicon Drive  
Durham, North Carolina, USA 27703  
[www.cree.com/rf](http://www.cree.com/rf)

Sarah Miller  
Marketing  
Cree, RF Components  
1.919.407.5302

Ryan Baker  
Marketing  
Cree, RF Components  
1.919.407.7816

Tom Dekker  
Sales Director  
Cree, RF Components  
1.919.313.5639